

Motion control

Lexium Easy 26

Servo drives and servo motors for simple machines

Catalog

December 2018



Introducing the **Easy** line
Essential automation & control products

When just enough is just right!

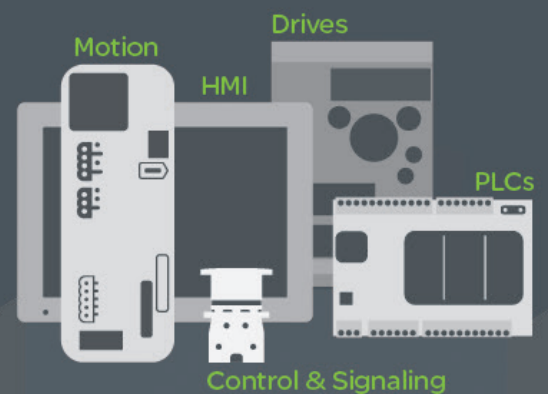

Schneider
Electric

Contents

Lexium Easy 26 motion control

■ Presentation

- Introduction, applications page 2
- A user-oriented range of products page 3
- Presentation of Lexium Easy 26 servo drives page 4
- Presentation of BCH2 servo motors page 5

■ Combinations

- Lexium Easy 26 servo drives and BCH2 servo motors page 6

■ Lexium Easy 26 servo drives

- Description page 8
- References and dimensions page 8
- Accessories and options:
 - Configuration tools page 9
 - Connection accessories page 10
 - Braking resistors (option) page 11
 - Additional EMC input filters page 12
 - Protection using fuses page 13

■ BCH2 servo motors

- Description page 14
- References and dimensions page 15
- Accessories and options:
 - Holding brake controller (option) page 16
 - Motor power cordsets, connector kits page 17
 - Connection components page 18

■ Index

- Reference index page 20



Lexium Easy 26 servo drive + servo motor (example)



Material working application



Material handling application

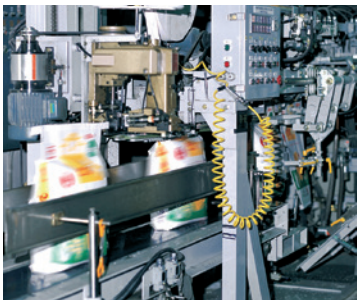

Packaging application



Textile application



SoMove setup software



Multi-Loader tool

Introduction

The Lexium™ Easy 26 range is defined by AC-servo drives lexium 26 for combination with AC-servo motors BCH2 according to customer's application.

- The Lexium Easy 26 range offers predefined combinations to suit the requirements of motion control applications and optimize the installation's performance.
 - The combinations of servo motors with servo drives are based on the power class: both the servo motor and servo drive have the same power class (1).
 - The combination of each servo drive with its related servo motor is designed to cover a nominal power range from 0.05 kW/0.07 hp up to 7.5 kW/10.06 hp with 200..240 V mains supply voltage (1).
- The Lexium Easy 26 servo drives have degree of protection IP 20.
- BCH2 motors provide a nominal torque from 0.16 Nm to 28.6 Nm and a nominal speed from 1,000 to 3,000 rpm, depending on the model. They are suitable for a wide variety of applications due to the different levels of motor inertia offered.

Applications

- Material working (multi-axis machines, cutting machines, etc.)
- Material handling (conveying, palletizers, warehousing, etc.)
- Assembly line (clamping, etc.)
- Packaging
- Printing
- Winding and unwinding
- Textiles
- Machine tools
- Plastic and rubber

SoMove setup software: For commissioning and configuration

SoMove software is used for commissioning, parameter setting, diagnostics and maintenance.

The drives can be configured:

- via their integrated HMI interface
- or using the SoMove setup software

It can also be used for fast device replacement in existing machine installations.

- SoMove setup software is used in just the same way as it is in other Schneider Electric drives, for configuring and optimizing control loops in automatic or manual mode using the Oscilloscope function and for maintenance of the Lexium Easy 26 drive.
- It can be used with the USB/RJ45 connection cable TCSMCNAM3M002P (see our SoMove software catalog or our website www.schneider-electric.com).

Multi-Loader tool

The Multi-Loader tool enables configurations to be copied from a PC or a servo drive and loaded onto another servo drive. The servo drives do not need to be powered up (see page 9).

Mounting and maintenance

Connecting the servo drives is simplified by identified plug-in connectors, which are easily accessed on the front panel of the drive (see Description page 8).

(1) See table of combinations page 6.

Lexium Easy 26 range: specially designed for simple machines

A user-oriented range of products

Lexium Easy 26 servo drive and BCH2 servo motor combinations are specially designed for easy integration & commissioning in your machine. They provide the right level of performance for the majority of simple motion control machines.

Fit for purpose

- Lexium Easy 26 servo drives have digital and analog I/O as standard.
- The servo drives incorporate numerous functions, including auto-tuning, position/speed/torque control and position sequence mode.
- The compact dimensions of Lexium Easy 26 servo drives mean they fit very easily into small spaces, thus reducing the size of the installation and the cost of the equipment.

Easy throughout the whole life cycle

- Easy to select and order thanks to the “just enough” number of references
- Easy to mount and wire up
- Easy to set up and commission thanks to SoMove software
- Easy to tune due to easy, comfortable and auto-adaptive tuning function
- Easy to connect to our range of Modicon Easy M200/M100 logic controllers

Robustness

- Motor shafts have degree of protection IP 65 as standard
- The motors can operate in temperatures from - 20 to 40 °C/-4 to 104 °F
- The drive printed circuit boards are coated for enhanced robustness in polluted environments

Widely available everywhere

- Fast delivery through a large distribution network
- Fast access to information and support through the Partner Relationship Management tool and a dedicated network of engineers



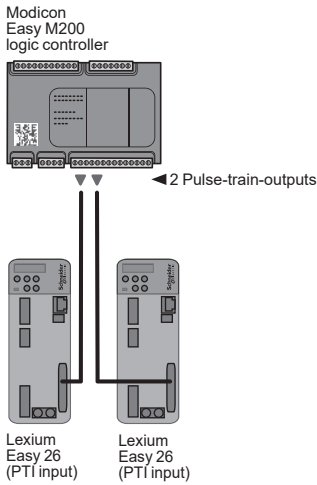

Example of architecture with control by Modicon Easy M200 logic controller

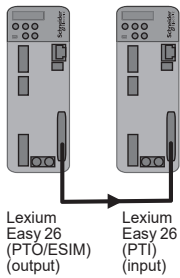

Example of a Lexim Eays 26 drive controlling another Lexium Easy 26 drive

Presentation of Lexium Easy 26 servo drives

Lexium Easy 26 servo drives feature numerous functions enabling them to be used in a wide range of motion control applications.

Main functions of Lexium Easy 26 servo drives

- Automatic motor identification by the servo drive: the technical data related to the motor is provided from the motor to the drive via the encoder connection cable.
- Filtering: Anti-vibration function for suppression of resonance frequencies in the power train connected with the moving mass of the application
- Monitoring functions:
 - Status monitoring, I/O monitoring
 - Log function to memorize alarm and warning messages (in the drive)
 - Reset function for alarms and warnings
 - Monitoring of drive variables related to motor control and closed loop control

Additional functions of Lexium Easy 26 servo drives

- Movement control with digital input interface directly in the servo drive:
 - Relative or absolute positioning mode
 - Velocity mode
 - Torque control mode
 - Position sequence mode: a sequence of up to 32 movements, controlled by a digital input interface

Control via I/O interface

The Lexium 26 servo drive is controlled with numerous digital and analog signals, accessible via the “CN1 IO” interface:

- 2 digital inputs for high-performance position capture
- 8 digital inputs
- 5 digital outputs
- 2 analog inputs
- 2 analog outputs

Drive functions activated by the commissioning software or directly by the HMI interface

- Jog mode: Velocity movement
- “Easy tuning” one-button tuning mode: this function is used to optimize application performance.
- 2 additional tuning functions, which can be activated by the SoMove commissioning software or by the HMI interface:
 - “Comfort tuning” with predefined settings for different mechanical systems such as spindle axes (e.g. portal axes), transportation belts, vertical axes (e.g. cantilever axes)
 - “Auto-adaptive tuning”

Operating modes for the Lexium Easy 26 via the PTI interface

The movement of Lexium Easy 26 drives can be managed by a machine controller (Modicon M200 logic controller) with pulse-train-input (PTO) interface or the ESIM (Encoder Simulator) interface from another (Lexium Easy 26) servo drive.

The corresponding pulse-train-input (PTI) of the Lexium Easy 26 drive is then electrically connected to the CN1 I/O interface.



BCH2 servo motor with flying lead connection and terminal connectors



BCH2 servo motor with MIL connectors

Presentation of BCH2 servo motors

BCH2 motors are synchronous AC servo motors.

- They are equipped as standard with a high-resolution (20-bit) single-turn or multi-turn absolute encoder. They are therefore ideal for high-performance applications such as material working, machine tools, etc.
- They are available in six flange sizes: 40 mm/1.57 in., 60 mm/2.36 in., 80 mm/3.15 in., 100 mm/3.94 in., 130 mm/5.12 in. and 180 mm/7.09 in.
- They are available with holding brake as an option.
- Depending on flange size, the BCH2 motors are supplied:
 - with flying leads and terminal connectors
 - or with MIL connectors

With the three types of motor inertia available, ranging from low to high inertia, the servo motors can be used in a very wide variety of applications:

- Low inertia: power between 0.2 kW/0.27 hp and 2 kW/2.68 hp, suitable for textile and packaging applications.
- Medium inertia: power between 0.05 kW/0.07 hp and 7.5 kW/10.06 hp, suitable for material working and machine tool applications.
- High inertia: 0.75 kW/1.01 hp power, suitable for metal working and printing applications.

Holding brake

BCH2 servo motors can be equipped with an electromagnetic holding brake.

⚠ Do not use the holding brake as a dynamic brake for deceleration, as this will quickly damage the brake.

Integrated encoder

BCH2 servo motors are equipped with a 20-bit single-turn or multi-turn absolute encoder.

These absolute encoders perform the following functions:

- measures the servo motor speed via the associated Lexium Easy 26 servo drive (this information is used by the servo drive's position and speed controller)
- sends data from the servo motor to the servo drive, which provides automatic identification of the motor when the servo drive starts

This encoder measures the motor angular position with a precision of ± 2.6 arc minutes.

The multi-turn absolute encoder also measures the number of motor turns.



Example of combination:
 - 1 Lexium Easy 26 servo drive (50 to 100 W)
 - 1 BCH2 servo motor with flying lead connection and 40 mm flange



Example of combination:
 - 1 Lexium Easy 26 servo drive (850 W to 1.5 kW)
 - 1 BCH2 servo motor with MIL connectors and 130 mm flange

Lexium Easy 26 servo drive and BCH2 servo motor combinations								
Power output	Nominal speed of rotation	Nominal torque	Max peak torque	With holding brake	Servo drive reference	Servo motor reference	Inertia (without holding brake)	Motor inertia type
kW/hp	min ⁻¹	Nm	Nm				kgcm ²	
Single-phase and three-phase supply voltage: 200/240 VAC								
0.05/ 0.07	3,000	0.16	0.48	Yes	LXM26DUA5M3X	BCH2MBA533CF5C	0.054	Medium
				No		BCH2MBA533CA5C		
0.1/ 0.13	3,000	0.32	0.96	Yes	LXM26DU01M3X	BCH2MB0133CF5C	0.075	Medium
				No		BCH2MB0133CA5C		
0.2/ 0.27	3,000	0.64	1.92	Yes	LXM26DU02M3X	BCH2LD0233CF5C	0.16	Low
				No		BCH2LD0233CA5C		
0.3/ 0.40	1,000	2.86	8.59	Yes	LXM26DU04M3X	BCH2MM0313CF6C	6.63	Medium
				No		BCH2MM0313CA6C		
0.4/ 0.54	3,000	1.27	3.81	Yes	LXM26DU04M3X	BCH2LD0433CF5C	0.27	Low
				No		BCH2LD0433CA5C		
0.4/ 0.54	3,000	1.27	3.81	Yes	LXM26DU04M3X	BCH2LF0433CF5C	0.67	Low
				No		BCH2LF0433CA5C		
0.5/ 0.67	2,000	2.39	7.16	Yes	LXM26DU07M3X	BCH2MM0523CF6C	6.63	Medium
				No		BCH2MM0523CA6C		
0.6/ 0.80	1,000	5.73	17.19	Yes	LXM26DU07M3X	BCH2MM0613CF6C	6.63	Medium
				No		BCH2MM0613CA6C		
0.75/ 1.01	3,000	2.39	7.16	Yes	LXM26DU07M3X	BCH2LF0733CF5C	1.19	Low
				No		BCH2LF0733CA5C		
0.75/ 1.01	3,000	2.39	7.16	Yes	LXM26DU07M3X	BCH2HF0733CF5C	1.54	High
				No		BCH2HF0733CA5C		
0.85/ 1.14	1,500	5.39	13.8	Yes	LXM26DU10M3X	BCH2MM0813CF6C	13.5	Medium
				No		BCH2MM0813CA6C		
0.9/ 1.21	1,000	8.59	25.77	Yes	LXM26DU10M3X	BCH2MM0913CF6C	9.7	Medium
				No		BCH2MM0913CA6C		
1/ 1.34	3,000	3.18	9.54	Yes	LXM26DU10M3X	BCH2LH1033CF6C	2.4	Low
				No		BCH2LH1033CA6C		
1/ 1.34	2,000	4.77	14.3	Yes	LXM26DU10M3X	BCH2HM1023CF6C	8.41	High
				No		BCH2HM1023CA6C		
1.5/ 2.01	2,000	7.16	21.48	Yes	LXM26DU15M3X	BCH2MM1523CF6C	9.7	Medium
				No		BCH2MM1523CA6C		

PF140887



Example of combination:
 - 1 Lexium Easy 26 servo drive (2 kW)
 - 1 BCH2 servo motor with MIL connectors and 130 mm flange

LXM26_62979_CPSC17001B



Example of combination:
 - 1 Lexium Easy 26 servo drive (7.5 kW)
 - 1 BCH2 servo motor with MIL connector and 180 mm flange

Lexium Easy 26 servo drive and BCH2 servo motor combinations									
Power output	Nominal speed of rotation	Nominal torque	Max peak torque	With holding brake	Servo drive reference	Servo motor reference	Inertia (without holding brake)	Motor inertia type	
kW/hp	min ⁻¹	Nm	Nm				kgcm ²		
Three-phase supply voltage: 200/240 VAC									
2.0/ 2.68	3,000	6.37	19.11	Yes	LXM26DU20M3X	BCH2LH2033CF6C	4.26	Low	
				No		BCH2LH2033CA6C			
2.0/ 2.68	2,000	9.55	28.65	Yes	LXM26DU20M3X	BCH2MM2023CF6C	13.5	Medium	
				No		BCH2MM2023CA6C			
2.0/ 2.68	2,000	9.55	28.65	Yes	LXM26DU20M3X	BCH2HR2023CF6C	34.68	High	
				No		BCH2HR2023CA6C			
3.0/ 4.02	1,500	14.32	42.97	Yes	LXM26DU30M3X	BCH2MR3023CF6C	53.56	Medium	
				No		BCH2MR3023CA6C			
3.0/ 4.02	2,000	19.1	57.29	Yes	LXM26DU30M3X	BCH2MR3013CF6C	53.56	Medium	
				No		BCH2MR3013CA6C			
3.5/ 4.69	2,000	16.7	50.3	Yes	LXM26DU45M3X	BCH2MR3523CF6C	53.56	Medium	
				No		BCH2MR3523CA6C			
4.5/ 6.03	1,500	26.65	71.62	Yes	LXM26DU45M3X	BCH2MR4513CF6C	73.32	Medium	
				No		BCH2MR4513CA6C			
5.5/ 7.39	1500	35.01	87.53	Yes	LXM26DU55M3X	BCH2MR5513●●6C	103.34	Medium	
				No		BCH2MR5513●A6C			
7.5/ 10.06	1500	47.75	119.37	Yes	LXM26DU75M3X	BCH2MR7513●●6C	142.7	Medium	
				No		BCH2MR7513●A6C			

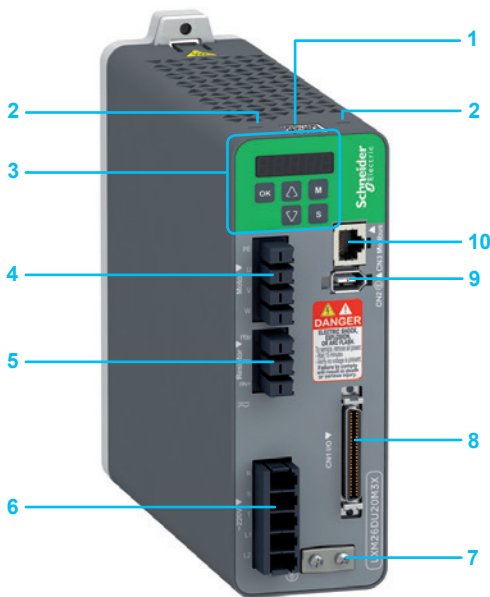

Description

On top of the drive:

- 1 QR code for access to detailed technical data, wiring guide and installation guide
- 2 Slot for application name plate

On the drive front:

- 3 HMI interface, 7-segment display, 5 buttons (OK, mode, set, value up, value down) and servo drive status LED
- 4 Removable terminal block (1), 4 terminals (PE, U, V, W) for motor connection (marked Motor)
- 5 Removable terminal block (1), 3 terminals (PBe, PBi, PA+) for braking resistor connection (marked Resistor)
- 6 Removable terminal block (1), 5 terminals (R, S, T, L1, L2) for connecting the 220 V ~ power supply (marked ~ 220 V)
- 7 Protected earth connector (marked ⊕)
- 8 Input/output interface connector (marked CN1 I/O)
- 9 Connector for motor encoder: 20-bit single-turn or multi-turn absolute encoder (marked CN2 ⊕)
- 10 RJ45 connector for Modbus serial link (marked CNE Modbus)

(1) Removable spring terminals are supplied with each servo drive.

References

To order a Lexium Easy 26 servo drive, make up the reference as follows:

Example	L	X	M	2	6	D	U	0	7	M	3	X	
Lexium Easy 26 AC servo drive	L	X	M	2	6								
Interface	I/O interface						D						
Power	0.05 kW/0.07 hp						U	A	5				
	0.1 kW/0.13 hp						U	0	1				
	0.2 kW/0.27 hp						U	0	2				
	0.4 kW/0.54 hp						U	0	4				
	0.75 kW/1.01 hp						U	0	7				
	1 kW/1.34 hp						U	1	0				
	1.5 kW/2.01 hp						U	1	5				
	2 kW/2.68 hp						U	2	0				
	3 kW/4.02 hp						U	3	0				
	4.5 kW/6.03 hp						U	4	5				
	5.5 kW/7.39 hp						U	5	5				
	7.5 kW/10.06 hp						U	7	5				
Supply voltage	200...240 V ~										M	3	X

Dimensions, weight

		Servo drives LXM26DU●●M3X				
		DUA5, DU01, DU02, DU04, DU07	DU10, DU15	DU20	DU30, DU45	DU55, DU75
Overall dimensions						
Width x	mm	55 x 150	55 x 150	62 x 170	117.4 x 234	157 x 304
Height	in.	2.17 x 5.91	2.17 x 5.91	2.44 x 6.69	4.62 x 9.21	6.18 x 11.97
Depth	mm	146	177	191.6	193	217
	in.	5.75	6.97	7.54	7.60	8.54
Weight						
kg / lb		1.000 / 2.190	1.200 / 2.630	1.700 / 3.720	3.200 / 7.010	7.800 / 17.196

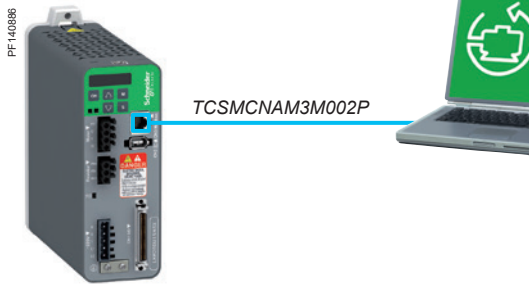

Configuration with the SoMove setup software

SoMove setup software

SoMove setup software is used on Lexium Easy 26 servo drives in the same way as it is on other Schneider Electric drives and starters, to configure, adjust, debug, and maintain the drive.

A configuration can be transferred from a PC to the Lexium Easy 26 servo drive via the USB/RJ45 cordset TCSMCNAM3M002P (used between the PC and the Lexium Easy 26, on the CN3 interface).

SoMove setup software can be downloaded from our website www.schneider-electric.com. For presentation, description, and references, see catalogue SoMove software on our website www.schneider-electric.com.



Reference

Description	Reference	Weight kg/lb
USB/RJ45 cordset Used to connect a PC to the device (Lexium Easy 26); this cable is 2.5 m/8.20 ft long and has a USB connector (PC end) and an RJ45 connector (device end)	TCSMCNAM3M002P	—



Configuration of a Lexium Easy 26 in its packaging with the VW3A8121 Multi-Loader tool + VW3A8126 cordset

Multi-Loader configuration tool

The Multi-Loader tool enables several configurations to be copied from a PC or a servo drive and loaded onto another servo drive.
The Lexium Easy 26 servo drives do not need to be powered up.

References

Description	Reference	Weight kg/lb
Multi-Loader configuration tool Supplied with: <ul style="list-style-type: none"> ■ 1 cordset equipped with 2 RJ45 connectors ■ 1 cordset equipped with one type A USB connector and one mini B USB connector ■ 1 x 2 GB SD memory card ■ 1 x female/female RJ 45 adapter ■ 4 AA 1.5 V LR6 round batteries 	VW3A8121	—



Cordset for Multi-Loader tool

For connecting the Multi-Loader tool to the Lexium Easy 26 servo drive in its packaging.

Equipped with:

- A non-locking RJ45 connector with special mechanical catch on the drive end and
- An RJ45 connector on the Multi-Loader end

VW3A8126



VW3M1C12

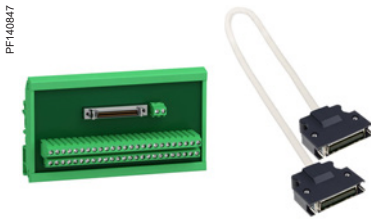

VW3M1C13

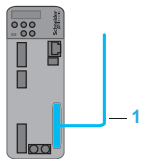

VW3M1C10R●●



VW3M2501



Servo drive with application name plate VW3M2501

Connection accessories

Connectors				
Designation	For use with	Description	Unit reference	Weight kg/lb
Replacement connector sets (sold in lots of 3)	0.05 kW/0.07 hp, 0.1 kW/0.13 hp, 0.2 kW/0.27 hp, 0.4 kW/0.54 hp, 0.75 kW/1.01 hp, 1 kW/1.34 hp and 1.5 kW/2.01 hp drives	3 connectors: □ 1 for motor □ 1 for resistor □ 1 for 220 V ~ power	VW3M4C21	0.100/ 0.220
	2 kW/2.68 hp drive	3 connectors: □ 1 for motor □ 1 for resistor □ 1 for 220 V ~ power	VW3M4C23	0.100/ 0.220
	3 kW/4.02 hp and 4.5 kW/6.03 hp drives	3 connectors: □ 1 for motor □ 1 for resistor □ 1 for ~ 220V power	VW3M4C24	0.100/ 0.220

I/O connector (sold in lots of 3)	Lexium Easy 26	Sub-D 50-pin connector for CN1 I/O interface	VW3M1C12	0.100/ 0.220
--	----------------	--	-----------------	-----------------

I/O terminal block module	Lexium Easy 26	Terminal block + Cordset (consisting of 2 Sub-D 50-pin connectors type VW3M1C12 and 0.5 m/1.640 ft. cable) for CN1 I/O interface connection	VW3M1C13	0.380/ 0.838
----------------------------------	----------------	---	-----------------	-----------------

I/O connection cordsets

Description	Use	Length m/ft	Reference	Weight kg/lb
Equipped with one SUB-D 50-pin connector for connection to the CN1 interface (drive end), and open end (controller end) (item 1)	This cable is dedicated to Schneider Electric PLCs, type Modicon M218/M221/M241/M200, for controlling Lexium Easy 26 servo drives with pulse-train-output (PTO) and pulse-train-input (PTI) signals.	1/ 3.28	VW3M1C10R10	0.100/ 0.220
		2/ 6.56	VW3M1C10R20	0.200/ 0.441
		3/ 9.84	VW3M1C10R30	0.300/ 0.661

Accessories

Description	Use	Dimensions mm /in.	Unit reference	Weight kg/lb
Application name plate (sold in lots of 50)	This contains information about the servo drive. To be inserted in a dedicated slot on top of the servo drive	38.5 x 13/ 1.516 x 0.512	VW3M2501	0.100/ 0.220

Presentation

Internal braking resistor

A braking resistor is built into the servo drive to absorb the braking energy. If the DC bus voltage in the servo drive exceeds a specified value, this braking resistor is activated. The restored energy is converted into heat by the braking resistor. It enables maximum transient braking torque.

External braking resistor

When the servo motor has to be braked frequently, an external braking resistor is required to dissipate the excess braking energy. In this case, the internal braking resistor must be deactivated.

Several external braking resistors can be connected in parallel. The servo drive monitors the power dissipated in the braking resistor.

The casing degree of protection is IP 65 for VW3A7601R●● to VW3A7607R●● braking resistors and IP 20 for VW3A77●● braking resistors.

The operating temperature around the unit can be between 0 and + 50°C/+ 32 and + 122 °F. To optimize the size of the braking resistor, the DC buses on Lexium Easy 26 servo drives in the same installation can be connected in parallel.

Applications

Machines with high inertia, driving loads, and machines with fast cycles.

References

External braking resistor

Ohmic value	Continuous power	Peak energy	Length of connection cable	Reference	Weight
Ω	W	230 V Ws	m/ft		kg/lb
10	400	13,300	0.75/ 2.46	VW3A7601R07	1.420/ 3.131
			2/ 6.56	VW3A7601R20	1.470/ 3.241
			3/ 9.84	VW3A7601R30	1.620/ 3.571
10	956	–	–	VW3A7734	5.500/ 12.125
16	956	–	–	VW3A7733	4.000/ 8.818
27	100	3,800	0.75/ 2.46	VW3A7602R07	0.630/ 1.389
			2/ 6.56	VW3A7602R20	0.780/ 1.720
			3/ 9.84	VW3A7602R30	0.900/ 1.984
	200	7,400	0.75/ 2.46	VW3A7603R07	0.930/ 2.050
			2/ 6.56	VW3A7603R20	1.080/ 2.381
			3/ 9.84	VW3A7603R30	1.200/ 2.646
	400	18,100	0.75/ 2.46	VW3A7604R07	1.420/ 3.131
			2/ 6.56	VW3A7604R20	1.470/ 3.241
			3/ 9.84	VW3A7604R30	1.620/ 3.571
72	200	9,600	0.75/ 2.46	VW3A7606R07	0.930/ 2.050
			2/ 6.56	VW3A7606R20	1.080/ 2.381
			3/ 9.84	VW3A7606R30	1.200/ 2.646
	400	24,700	0.75/ 2.46	VW3A7607R07	1.420/ 3.131
			2/ 6.56	VW3A7607R20	1.470/ 3.241
			3/ 9.84	VW3A7607R30	1.620/ 3.571

Note: The total continuous power dissipated in the external braking resistor(s) must be less than or equal to the nominal power of the Lexium Easy 26 servo drive.



VW3A7601R●●



VW3A7734

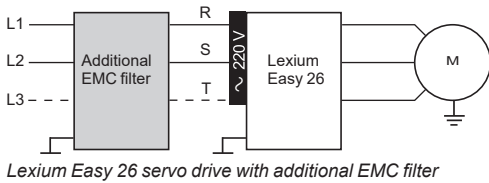

Presentation

Lexium Easy 26 servo drives require external input filters to comply with the EMC standard for variable speed electrical power drive “products” IEC/EN 61800-3, edition 2, category C3 in environment 2, and to comply with the European directive on EMC (electromagnetic compatibility).

Applications

Additional EMC filters are mounted next to the device. They have tapped holes for mounting in an enclosure. The maximum servo motor cable length conforming to IEC/EN 61800-3 category C3 (1) in environment 2 is 20 m/65.62 ft.

Use according to the type of line supply

Integrated or additional EMC filters can only be used on TN (neutral connection) or TT (neutral to ground) systems. Lexium Easy 26 servo drives cannot be used on IT (impedance grounded or isolated neutral) systems. Standard IEC/EN 61800-3, appendix D2.1, states that on IT systems, filters can cause permanent insulation monitors to operate in a random manner.

If a machine has to be installed on an IT system, an isolation transformer must be inserted in order to recreate a TT system on the secondary side.

References

Additional EMC input filters

For servo drives (max. nominal power) Combination	Line current (A)	Reference	Weight kg/lb
Single-phase supply voltage			
50 W to 750 W servo drives 1 x EMC filter and a single Lexium Easy 26 servo drive	9	VW3A4420	0.600/ 1.323
1 kW and 1.5 kW servo drives 1 x EMC filter and a single Lexium Easy 26 servo drive	16	VW3A4421	0.775/ 1.709
7.5 kW max servo drives 1 x common EMC filter and several Lexium Easy 26 servo drives	24	VW3A4426	1.130/ 2.491
Three-phase supply voltage			
50 W to 1.5 kW, 2kW and 3kW servo drives 1 x EMC filter and a single Lexium Easy 26 servo drive	15	VW3A4422	0.900/ 1.984
4.5 kW servo drives 1 x EMC filter and a single Lexium Easy 26 servo drive	25	VW3A4423	1.350/ 2.976
Up to 10 kW servo drives 1 x common EMC filter and several Lexium Easy 26 servo drives	47	VW3A4424	3.150/ 6.945

(1) Standard IEC/EN 61800-3: EMC immunity and conducted and radiated EMC emissions:
- Category C3 in environment 2: industrial premises.



EMC filter (VW3A4420) and Lexium Easy 26 servo drive

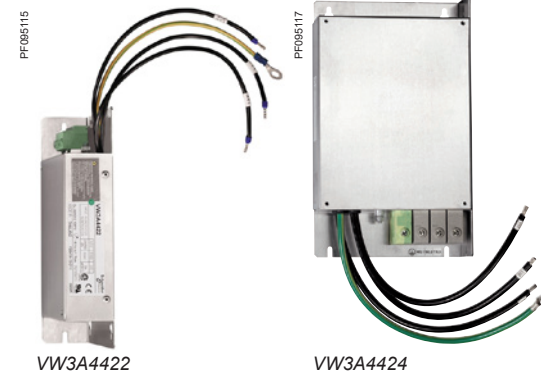

VW3A4422

VW3A4424

Lexium Easy 26 motion control

Motor starters

Protection using fuses



GV2P●●

+



LC1●●●

+



LXM26DU●●M3X

Applications

The combinations listed below can be used to create a complete motor starter unit comprising a circuit-breaker, a contactor and a Lexium Easy 26 servo drive.

- The circuit-breaker provides protection against accidental short-circuits, disconnection and, if necessary, isolation.
- The contactor activates and manages any safety functions, as well as isolating the servo motor on stopping.

The servo drive controls the servo motor, provides protection against short-circuits between the servo drive and the servo motor and protects the motor cable against overloads. Overload protection is provided by the servo drive's motor thermal protection.

Combinations

Servo drive		Circuit-breaker		Contactor	
Reference	Nominal power (kW/hp)	Mains number of phases	Reference	Rating (A)	Reference (1) (2)
Circuit-breakers for single drive installation according to IEC 60364-5-52					
Mains supply voltage: 200...240 V ~ 50/60Hz					
LXM26DUA5M3X	0.05/0.07	1 or 3 phases	GV2P14	10	LC1K0610●●
LXM26DU01M3X	0.1/0.13	1 or 3 phases	GV2P14	10	LC1K0610●●
LXM26DU02M3X	0.2/0.27	1 or 3 phases	GV2P14	10	LC1K0610●●
LXM26DU04M3X	0.4/0.54	1 or 3 phases	GV2P14	10	LC1K09●●
LXM26DU07M3X	0.75/1.01	1 or 3 phases	GV2P14	10	LC1K09●●
LXM26DU10M3X	1/1.34	1 or 3 phases	GV2P14	10	LC1K12●●
LXM26DU15M3X	1.5/2.01	1 or 3 phases	GV2P16	14	LC1D18●●
LXM26DU20M3X	2/2.68	3 phases	GV2P20	18	LC1D32●●
LXM26DU30M3X	3/4.02	3 phases	GV2P20	18	LC1D32●●
LXM26DU45M3X	4.5/6.03	3 phases	GV2P21	23	LC1D65●●
LXM26DU55M3X	5.5/7.39	3 phases	GV2P32	32	LC1D65●●
LXM26DU75M3X	7.5/10.06	3 phases	GV3P65	65	LC1D65●●

(1) Composition of the contactors:

LC1 K06: 3 poles + 1 N/O auxiliary contact

LC1 D●●: 3 poles + 1 N/O auxiliary contact + 1 N/C auxiliary contact

Please refer to the "Control and protection components" catalog.

(2) Replace ●● with the control circuit voltage code given in the table below:

	Volts ~	220	230	240
LC1K	50/60 Hz	M7	P7	U7
	Volts ~	220/230	230	230/240
LC1D	50 Hz	M5	P5	U5
	60 Hz	M6	-	U6
	50/60 Hz	M7	P7	U7

For other available voltages between 24 V and 660 V, or a DC control circuit, please contact our Customer Care Center.

Protection using class J fuses (UL certification)

Servo drive	Nominal power (kW/hp)	Fuse to be placed upstream (A)
Mains supply voltage: 200...240 V ~ 50/60Hz		
LXM26DUA5M3X	0.05/0.07	5
LXM26DU01M3X	0.1/0.13	5
LXM26DU02M3X	0.2/0.27	5
LXM26DU04M3X	0.4/0.54	20
LXM26DU07M3X	0.75/1.01	20
LXM26DU10M3X	1/1.34	25
LXM26DU15M3X	1.5/2.01	40
LXM26DU20M3X	2/2.68	60
LXM26DU30M3X	3/4.02	80
LXM26DU45M3X	4.5/6.03	160
LXM26DU55M3X	5.5/7.39	63
LXM26DU75M3X	7.5/10.06	63

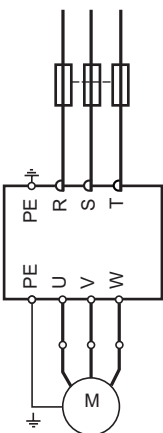

LXM26 servo drive, BCH2 servo motor with fuse protection

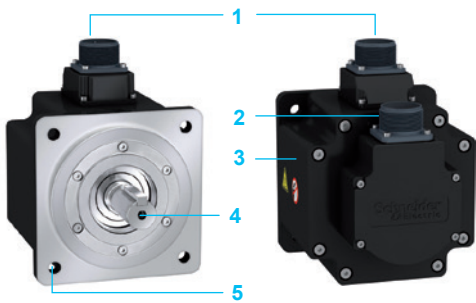

BCH2 servo motors

BCH2 servo motors, with a 3-phase stator and a rotor with rare earth permanent magnets, consist of:

- 1 A connector for the power cable
- 2 A connector for the encoder cable
- 3 Casing with RAL 9005 opaque black paint coating
- 4 A keyed shaft end with oil seal
- 5 4-point axial mounting flange (flange is mechanically compatible with Asian style servo motors)

Cables and connectors to be ordered separately, for connection to Lexium Easy 26 servo drives. Schneider Electric has taken particular care over the compatibility of BCH2 servo motors and Lexium Easy 26 servo drives. This compatibility is only possible when using cables and connectors sold by Schneider Electric (see page 17).

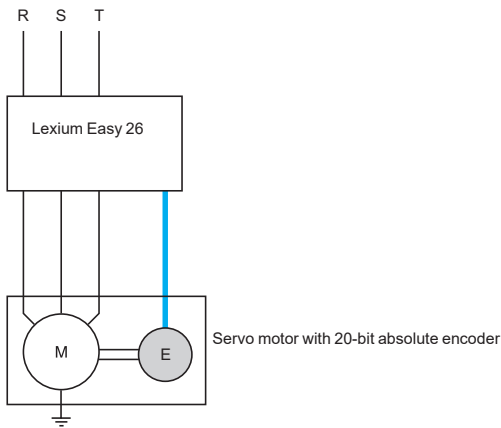

Integrated encoder in BCH2 servo motors

The standard measurement device for motor position and motor velocity is a 20-bit single-turn or multi-turn absolute encoder integrated in BCH2 servo motors. This measurement device is particularly suited to the Lexium Easy 26 range of servo drives.

Use of this interface enables:

- Automatic identification of BCH2 servo motor data by the servo drive
- Automatic initialization of the servo drive control loops, thus simplifying installation and drive commissioning at the machine

BCH2 servo motors														
References														
To order a BCH2 servo motor, make up the reference as follows:														
Brushless servo motor		B	C	H	2	•	•	••	•	•	C	•	•	C
Inertia	Low inertia					L								
	Medium inertia					M								
	High inertia					H								
Flange size	40 mm (1.58 in.)						B							
	60 mm (2.36 in.)						D							
	80 mm (3.15 in.)						F							
	100 mm (3.94 in.)						H							
	130 mm (5.12 in.)						M							
	180 mm (7.08 in.)						R							
Rated output	50 W (0.067 hp)							A5						
	100 W (0.13 hp)							01						
	200 W (0.26 hp)							02						
	300 W (0.41 hp)							03						
	400 W (0.53 hp)							04						
	500 W (0.67 hp)							05						
	600 W (0.80 hp)							06						
	750 W (1.00 hp)							07						
	850 W (1.13 hp)							08						
	1 kW (1.34 hp)							10						
	1.5 kW (2.01 hp)							15						
	2 kW (2.68 hp)							20						
	3 kW (4.02 hp)							30						
	3.5 kW (4.69 hp)							35						
4.5 kW (6.03 hp)							45							
5.5 kW (7.39 hp)							55							
7.5 kW (10.06 hp)							75							
Power supply ~ 220 V	1000/1500 rpm								1					
Winding type	2000 rpm								2					
	3000 rpm								3					
Shaft end	Keyed shaft (shaft & housing IP 65)									3				
Encoder	High resolution single-turn absolute encoder, 20-bit resolution										C			
	High resolution multi-turn absolute encoder, 20 bit resolution, 4096 turns										M			
Holding brake	Without brake											A		
	With brake (option)											F		
Connections	Free leads with connectors (BCH2•B/•D/•F motors only)												5	
	MIL connectors (BCH2•H/•M/•R motors only)													6
Mechanical motor design	Motor compatible with Asian style mounting standards													C

Dimensions and weight												
Servo motor	Pn	Flange	Dimensions (overall)						Weight			
			Servo motor without brake			Servo motor with brake			without brake		with brake	
			Width x Height x Depth (W x H x D)			Width x Height x Depth (W x H x D)			kg	lb	kg	lb
	W	mm	in.	mm	in.	mm	in.					
BCH2MBA533••5C	50	40	1.57	40 x 58.5 x 82	1.57 x 2.30 x 3.23	40 x 58.5 x 112	1.57 x 2.30 x 4.41	0.400	0.880	0.600	1.320	
BCH2MB0133••5C	100	40	1.57	40 x 58.5 x 100	1.57 x 2.30 x 3.94	40 x 58.5 x 130	1.57 x 2.30 x 5.12	0.560	1.230	0.770	1.700	
BCH2LD0233••5C	200	60	2.36	60 x 78.5 x 104	2.36 x 3.09 x 4.09	60 x 78.5 x 140	2.36 x 3.09 x 5.51	1.020	2.250	1.500	3.310	
BCH2LD0433••5C	400	60	2.36	60 x 78.5 x 129	2.36 x 3.09 x 5.08	60 x 78.5 x 165	2.36 x 3.09 x 6.50	1.450	3.200	2.000	4.410	
BCH2LF0433••5C	400	80	3.15	80 x 98.5 x 112	3.15 x 3.88 x 4.41	80 x 98.5 x 152	3.15 x 3.88 x 4.41	2.000	4.410	2.800	6.170	
BCH2HF0733••5C	750	80	3.15	80 x 98.5 x 138	3.15 x 3.88 x 5.43	80 x 98.5 x 178	3.15 x 3.88 x 7.01	2.900	6.390	3.700	8.160	
BCH2LF0733••5C	750	80	3.15	80 x 98.5 x 138	3.15 x 3.88 x 5.43	80 x 98.5 x 178	3.15 x 3.88 x 7.01	2.800	6.170	3.600	7.940	
BCH2LH1033••6C	1000	100	3.94	100 x 145.6 x 153.5	3.94 x 5.73 x 6.04	100 x 145.6 x 180.5	3.94 x 5.73 x 7.11	4.600	10.140	5.100	11.240	
BCH2LH2033••6C	2000	100	3.94	100 x 145.6 x 198.5	3.94 x 5.73 x 7.81	100 x 145.6 x 225.5	3.94 x 5.73 x 8.88	6.700	14.770	7.200	15.870	
BCH2MM0313••6C	300	130	5.12	130 x 175.6 x 147	5.12 x 6.91 x 5.79	130 x 175.6 x 183	5.12 x 6.91 x 7.20	7.000	15.430	8.200	18.080	
BCH2MM0523••6C	500	130	5.12	130 x 175.6 x 147	5.12 x 6.91 x 5.79	130 x 175.6 x 183	5.12 x 6.91 x 7.20	7.000	15.430	8.200	18.080	
BCH2HM1023••6C	1000	130	5.12	130 x 175.6 x 147	5.12 x 6.91 x 5.79	130 x 175.6 x 183	5.12 x 6.91 x 7.20	7.000	15.430	8.200	18.080	
BCH2MM0813••6C	850	130	5.12	130 x 175.6 x 187	5.12 x 6.91 x 7.36	130 x 175.6 x 216	5.12 x 6.91 x 8.50	9.600	21.160	10.900	24.030	
BCH2MM0913••6C	900	130	5.12	130 x 175.6 x 163	5.12 x 6.91 x 6.42	130 x 175.6 x 198	5.12 x 6.91 x 7.80	7.600	16.760	8.800	19.400	
BCH2MM1523••6C	1500	130	5.12	130 x 175.6 x 167	5.12 x 6.91 x 6.57	130 x 175.6 x 202	5.12 x 6.91 x 7.95	7.600	16.760	8.800	19.400	
BCH2MM2023••6C	2000	130	5.12	130 x 175.6 x 187	5.12 x 6.91 x 7.36	130 x 175.6 x 216	5.12 x 6.91 x 8.50	9.700	21.380	11.000	24.250	
BCH2HR2023••6C	2000	180	7.09	180 x 245.1 x 169	7.09 x 9.65 x 6.65	180 x 245.1 x 203	7.09 x 9.65 x 7.99	13.000	28.660	18.000	39.680	
BCH2MR3013••6C	3000	180	7.09	180 x 245.1 x 202	7.09 x 9.65 x 7.95	180 x 245.1 x 235	7.09 x 9.65 x 9.25	18.500	40.790	23.000	50.710	
BCH2MR3023••6C	3000	180	7.09	180 x 245.1 x 202	7.09 x 9.65 x 7.95	180 x 245.1 x 235	7.09 x 9.65 x 9.25	18.500	40.790	23.000	50.710	
BCH2MR3523••6C	3500	180	7.09	180 x 245.1 x 202	7.09 x 9.65 x 7.95	180 x 245.1 x 235	7.09 x 9.65 x 9.25	18.500	40.790	23.000	50.710	
BCH2MR4513••6C	4500	180	7.09	180 x 245.1 x 235	7.09 x 9.65 x 9.25	180 x 245.1 x 279	7.09 x 9.65 x 10.98	23.640	52.120	28.000	61.730	
BCH2MR5513••6C	5500	180	7.09	180 x 278 x 235	7.09 x 10.94 x 9.25	180 x 313 x 279	7.09 x 12.32 x 10.98	32.000	70.548	36.500	79.366	
BCH2MR7513••6C	7500	180	7.09	180 x 341 x 235	7.09 x 13.43 x 9.25	180 x 376 x 279	7.09 x 14.80 x 10.98	41.700	91.933	47.200	104.058	

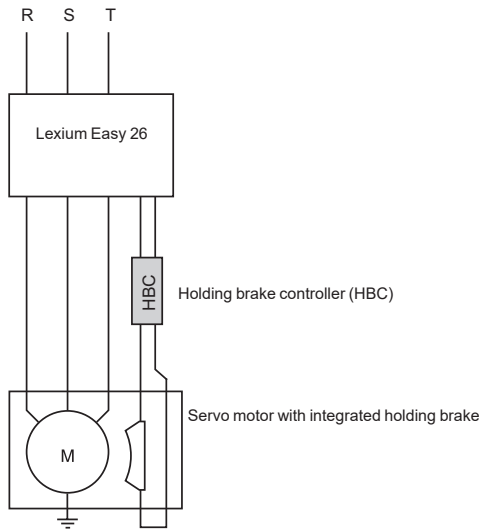

VW3M3103

Holding brake controller

Presentation

If a servo motor has a holding brake, it is necessary to provide an appropriate control logic (HBC, Holding Brake Controller), which releases the brake when power is supplied to the servo motor and immobilizes the servo motor shaft when it is stationary.

The holding brake controller amplifies the braking control signal (Digital output) transmitted by the Lexium Easy 26 servo drive, so that the brake is deactivated quickly. It then reduces this control signal so as to decrease the power dissipated by the holding brake.

References

Description	Description	Reference	Weight kg/lb
Holding brake controller	24 V $\overline{\text{---}}$ power supply Max. power 0.05 kW/0.07 hp IP 20, for mounting on 55 mm/2.17 in. \perp rail	VW3M3103	0.600/ 1.323

Lexium Easy 26 motion control

BCH2 servo motors

Connection components:

Motor power cordsets, connector kits

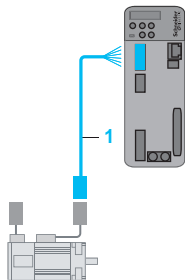

VW3M5D1●R●●

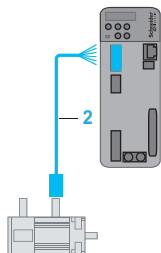

VW3M5D2●R●●
VW3M5D4●R●●
VW3M5D6●R●●
VW3M5D7●R●●
VW3M5D8●R●●

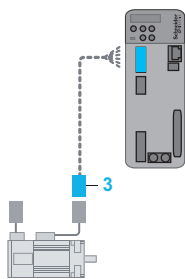

VW3M5D1●

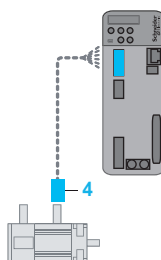

VW3M5D2●

Connection components for BCH2 servo motors

Power cable type						
Connector	AWG	mm ²	Length m/ft	Reference	Weight kg/lb	
Shielded power cordsets for BCH2 motors without brake						
Equipped with one quick connector (servo motor end), and open end (servo drive end) (item 1)	AWG18	4 x 1	1.5/	VW3M5D1AR15	0.200/	
			4.92		0.441	
			3/		0.300/	
			9.84	VW3M5D1AR30	0.661	
			5/	VW3M5D1AR50	0.450/	
			16.40		0.992	
Equipped with one MIL connector (servo motor end), and open end (servo drive end) (item 2)	AWG16	4 x 1.5	3/	VW3M5D2AR30	0.450/	
			9.84		0.992	
				5/	VW3M5D2AR50	0.700/
				16.40		1.543
	AWG12	4 x 4	3/	VW3M5D4AR30	0.750/	
			9.84		1.653	
				5/	VW3M5D4AR50	1.250/
				16.40		2.756
	AWG10	4 x 6	3/	VW3M5D6AR30	2.100/	
			9.84		4.630	
				5/	VW3M5D6AR50	3.400/
				16.40		7.496
		4 x 6	3/	VW3M5D7AR30	2.100/	
			9.84		4.630	
			5/	VW3M5D7AR50	3.400/	
			16.40		7.496	
AWG8	4 x 8	3/	VW3M5D8AR30	2.400/		
		9.84		5.291		
			5/	VW3M5D8AR30	3.800/	
			16.40		8.378	

Shielded power cordsets for BCH2 motors with brake

Equipped with one quick connector (servo motor end), and open end (servo drive end) (item 1)	AWG18	(4 x 1) + (2 x 1)	3/	VW3M5D1FR30	0.300/	
			9.84		0.661	
			5/		VW3M5D1FR50	0.450/
			16.40		0.992	
Equipped with one MIL connector (servo motor end), and a free lead (servo drive end) (item 2)	AWG16	(4 x 1.5) + (2 x 1)	3/	VW3M5D2FR30	0.650/	
			9.84		1.433	
				5/	VW3M5D2FR50	0.900/
				16.40		1.984
	AWG12	(4 x 4) + (2 x 1.5)	3/	VW3M5D4FR30	0.950/	
			9.84		2.094	
				5/	VW3M5D4FR50	1.450/
				16.40		3.197
	AWG10	(4 x 6) + (2 x 1.5)	3/	VW3M5D6FR30	3.000/	
			9.84		6.614	
				5/	VW3M5D6FR50	5.000/
				16.40		11.023
		(4 x 6) + (2 x 1.5)	3/	VW3M5D7AF30	2.200/	
			9.84		4.850	
			5/	VW3M5D7AF50	3.400/	
			16.40		7.496	
AWG8	(4 x 8) + (2 x 1.5)	3/	VW3M5D8FR30	2.500/		
		9.84		5.512		
			5/	VW3M5D8FR30	3.900/	
			16.40		8.598	

Motor power connector kits

Description	For use with	Unit reference	Weight kg/lb
Motor power connector kits (sold in lots of 3) (item 3)	BCH2●B/●D/●F motors (flange size: 40/60/80 mm) with flying lead connection, without brake	VW3M5D1A	0.150/0.331
	BCH2●B/●D/●F motors (flange size: 40/60/80 mm) with flying lead connection, with brake	VW3M5D1F	0.150/0.331
Power MIL connector kits (item 4)	BCH2●H/●M motors (flange size: 100/130 mm) with or without brake	VW3M5D2A	0.300/0.661
	BCH2●R motors (flange size: 180 mm, from 2.0 kW to 5.5 kW) with or without brake	VW3M5D2B	0.300/0.661
	BCH2●R motors (flange size 180 mm, 7.5 kW)	VW3M5D2C	0.300/0.661

Lexium Easy 26 motion control

BCH2 servo motors

Connection components:

Shielded encoder cordsets, encoder connector kits

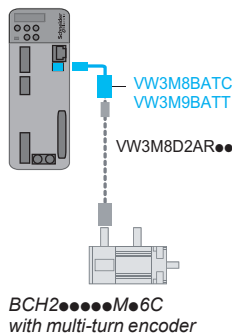
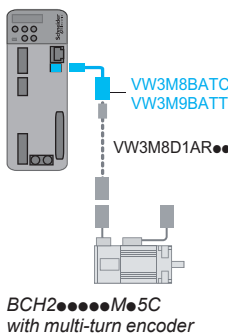
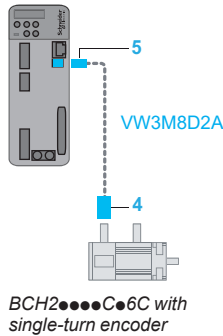
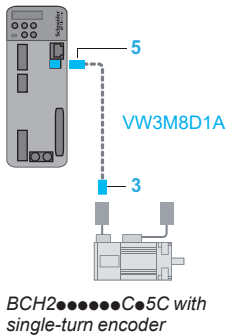
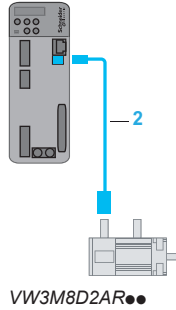
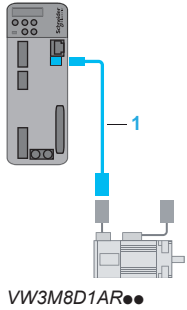

Connection components for BCH2 servo motors

Description	For use with	Composition	Length m/ft	Reference	Weight kg/lb
Shielded encoder cordsets					
Equipped with one plastic connector (servo motor end), and a firewire connector (servo drive end) (item 1)	BCH2●B/●D/●F motors, for connection to CN2 interface	10 x 0.13 mm ² / 10 x 26 AWG	1.5/	VW3M8D1AR15	0.500/ 1.102
			4.92		
			3/ 9.84	VW3M8D1AR30	1.000/ 2.205
			5/ 16.40	VW3M8D1AR50	1.200/ 2.646
Equipped with one MIL connector (servo motor end), and a firewire connector (servo drive end) (item 2)	BCH2●H/●M/●R motors, for connection to CN2 interface	10 x 0.13 mm ² / 10 x 26 AWG	3/ 9.84	VW3M8D2AR30	1.300/ 2.866
			5/ 16.40	VW3M8D2AR50	1.500/ 3.307

Encoder connector kits

Encoder connector kits including one plastic connector (servo motor end), (item 3) and a firewire connector (servo drive end) (item 5) (sold in lots of 2)	BCH2●B/●D/●F motors (flange: 40/60/80 mm) with flying lead connection	–		VW3M8D1A	0.150/ 0.331
Encoder connector kits including one MIL connector (servo motor end), (item 4) and a firewire connector (servo drive end) (item 5) (sold in lots of 2)	BCH2●H/●M/●R motors (flange: 100/130/180 mm) with MIL connector	–		VW3M8D2A	0.150/ 0.331

Accessories for use with BCH2 motors with multi-turn absolute encoder

Battery compartment	BCH2 motors with multi-turn absolute encoder	–	–	VW3M8BATC	0.100/ 0.220
Battery 3.6 V	BCH2 motors with multi-turn absolute encoder and battery compartment "VW3M8BATC"	–	–	VW3M9BATT	0.050/ 0.110

Lexium Easy 26 motion control

BCH2 servo motors

Connection components:

Motor connector kits, encoder connector kits

Selection of motor connector kit or encoder connector kit, according to BCH2 motor type						
Motor	Motor power cable connector kit		Encoder connector kit	Motor power cable		Encoder cable
	Without brake	With brake		Without brake	With brake	
BCH2MBA53●●5C	VW3M5D1A	VW3M5D1F	VW3M8D1A	VW3M5D1AR●●	VW3M5D1FR●●	VW3M8D1AR●●
BCH2MB0133●●5C						
BCH2LD0233●●5C						
BCH2LD0433●●5C						
BCH2LF0433●●5C						
BCH2HF0733●●5C						
BCH2LF0733●●5C						
BCH2LH1033●●6C	VW3M5D2A	VW3M5D2A	VW3M8D2A	VW3M5D2AR●●	VW3M5D2FR●●	VW3M8D2AR●●
BCH2LH2033●●6C						
BCH2MM0813●●6C						
BCH2MM0313●●6C						
BCH2MM0523●●6C						
BCH2MM0613●●6C						
BCH2HM1023●●6C						
BCH2MM0913●●6C						
BCH2MM1523●●6C						
BCH2MM2023●●6C						
BCH2HR2023●●6C	VW3M5D2B	VW3M5D2B	VW3M8D2A	VW3M5D4AR●●	VW3M5D4FR●●	VW3M8D2AR●●
BCH2MR3013●●6C						
BCH2MR3023●●6C						
BCH2MR3523●●6C						
BCH2MR4513●●6C						
BCH2MR551●●●6C	VW3M5D2B	VW3M5D2B	VW3M8D2A	VW3M5D7AR●●	VW3M5D7FR●●	VW3M8D2AR●●
BCH2MR751●●●6C	VW3M5D2C	VW3M5D2C	VW3M8D2A	VW3M5D8AR●●	VW3M5D8FR●●	VW3M8D2AR●●

B			
BCH2HF0733CA5C	6	LXM26DU55M3X	7
BCH2HF0733CF5C	6	LXM26DU75M3X	7
BCH2HM1023CA6C	6	LXM26DUA5M3X	6
BCH2HM1023CF6C	6	TCSMCNAM3M002P	9
BCH2HR2023CA6C	7		
BCH2HR2023CF6C	7	V	
BCH2LD0233CA5C	6	VW3A4420	12
BCH2LD0233CF5C	6	VW3A4421	12
BCH2LD0433CA5C	6	VW3A4422	12
BCH2LD0433CF5C	6	VW3A4423	12
BCH2LF0433CA5C	6	VW3A4424	12
BCH2LF0433CF5C	6	VW3A4426	12
BCH2LF0733CA5C	6	VW3A7601R07	11
BCH2LF0733CF5C	6	VW3A7601R20	11
BCH2LF0733CF5C	6	VW3A7601R30	11
BCH2LH1033CA6C	6	VW3A7602R07	11
BCH2LH1033CF6C	6	VW3A7602R20	11
BCH2LH2033CA6C	7	VW3A7602R30	11
BCH2LH2033CF6C	7	VW3A7603R07	11
BCH2MB0133CA5C	6	VW3A7603R20	11
BCH2MB0133CF5C	6	VW3A7603R30	11
BCH2MBA533CA5C	6	VW3A7604R07	11
BCH2MBA533CF5C	6	VW3A7604R20	11
BCH2MM0313CA6C	6	VW3A7604R30	11
BCH2MM0313CF6C	6	VW3A7606R07	11
BCH2MM0523CA6C	6	VW3A7606R20	11
BCH2MM0523CF6C	6	VW3A7606R30	11
BCH2MM0613CA6C	6	VW3A7607R07	11
BCH2MM0613CF6C	6	VW3A7607R20	11
BCH2MM0813CA6C	6	VW3A7607R30	11
BCH2MM0813CF6C	6	VW3A7733	11
BCH2MM0913CA6C	6	VW3A7734	11
BCH2MM0913CF6C	6	VW3A8121	9
BCH2MM1523CA6C	6	VW3A8126	9
BCH2MM1523CF6C	6	VW3M1C10R10	10
BCH2MM2023CA6C	7	VW3M1C10R20	10
BCH2MM2023CF6C	7	VW3M1C10R30	10
BCH2MR3013CA6C	7	VW3M1C12	10
BCH2MR3013CF6C	7	VW3M1C13	10
BCH2MR3023CA6C	7	VW3M4C21	10
BCH2MR3023CF6C	7	VW3M4C23	10
BCH2MR3523CA6C	7	VW3M4C24	10
BCH2MR3523CF6C	7	VW3M5D1A	17
BCH2MR4513CA6C	7	VW3M5D1AR15	17
BCH2MR4513CF6C	7	VW3M5D1AR30	17
BCH2MR5513●A6C	7	VW3M5D1AR50	17
BCH2MR5513●●6C	7	VW3M5D1F	17
BCH2MR7513●A6C	7	VW3M5D1FR30	17
BCH2MR7513●●6C	7	VW3M5D1FR50	17
		VW3M5D2A	17
L		VW3M5D2AR30	17
LXM26DU01M3X	6	VW3M5D2AR50	17
LXM26DU02M3X	6	VW3M5D2B	17
LXM26DU04M3X	6	VW3M5D2C	17
LXM26DU07M3X	6	VW3M5D2FR30	17
LXM26DU10M3X	6	VW3M5D2FR50	17
LXM26DU15M3X	6	VW3M5D4AR30	17
LXM26DU20M3X	7	VW3M5D4AR50	17
LXM26DU30M3X	7	VW3M5D4FR30	17
LXM26DU45M3X	7	VW3M5D4FR50	17
		VW3M5D6AR30	17
		VW3M5D6AR50	17
		VW3M5D6FR30	17
		VW3M5D6FR50	17
		VW3M5D7AF30	17
		VW3M5D7AF50	17
		VW3M5D7AR30	17
		VW3M5D7AR50	17
		VW3M5D8AR30	17
		VW3M5D8FR30	17
		VW3M8BATC	18
		VW3M8D1A	18
		VW3M8D1AR15	18
		VW3M8D1AR30	18
		VW3M8D1AR50	18
		VW3M8D2A	18
		VW3M8D2AR30	18
		VW3M8D2AR50	18
		VW3M9BATT	18
		VW3M2501	10
		VW3M3103	16

Schneider Electric Industries SAS

Head Office
35, rue Joseph Monier
F-92500 Rueil-Malmaison
France

www.schneider-electric.com

The information provided in this documentation contains general descriptions and/or technical characteristics of the performance of the products contained herein. This documentation is not intended as a substitute for and is not to be used for determining suitability or reliability of these products for specific user applications. It is the duty of any such user or integrator to perform the appropriate and complete risk analysis, evaluation and testing of the products with respect to the relevant specific application or use thereof. Neither Schneider Electric nor any of its affiliates or subsidiaries shall be responsible or liable for misuse of the information contained herein.

Design: Schneider Electric
Photos: Schneider Electric